

INSTRUCTION MANUAL

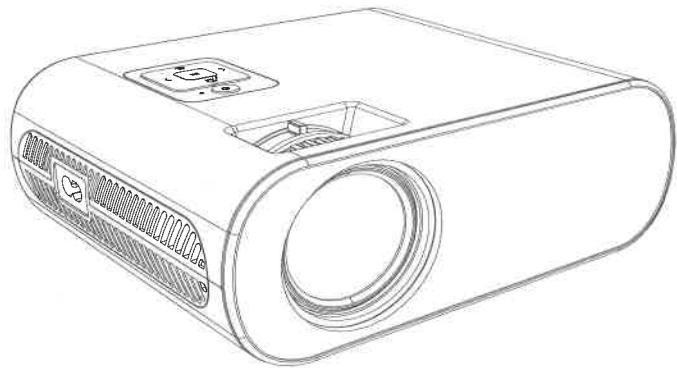

Model: C10

Please read this manual carefully
before using the projector.

Important Safety Considerations

Attentions:

Thank you for purchasing this series of digital projector.
Please read through this "User's manual" for proper use of this product.
Please keep this manual together with the warranty card in a safe place for reference as needed after reading.
Please read this "User's manual" to find things you need to know in use or in case of problems.

Note:

Do not open the enclosure to avoid electric shock. No components in the projector can be repaired by customers. Please entrust qualified professional maintenance personnel for repair.



The identification warns users of the voltage without insulating treatment in the projector, which may cause electric shock via surface magnetic field. Therefore, it's very dangerous to contact with any component inside the projector.



The identification reminds users to be very careful and cautious in the operation and maintenance. Therefore, carefully read the manual to avoid any failures.

Warning

Do not expose the projector to rain or moisture to avoid fire or electric shock; do not open the enclosure.

Important Safety Considerations

Identification [Electronic information product pollution control identification requirements]

(1) Name, content, and component of 6 hazardous substances included The name, content and component of 6 hazardous substances included in the product are as

follows: Name and content of toxic and hazardous substances in the product

Component Name	Toxic and Hazardous Substances or Element					
	Lead (Pb)	Mercury (Hg)	Cadmium (Cd)	Hexavalent Chromium (Cr ⁶⁺)	Polybrominated Biphenyls (PBB)	Polybrominated Diphenyl Ethers (PBDE)
Real Equipment						
Base Plate						
Framework						
Light source						
Connecting Wires Between Machines						

Note (meaning of or ×)
indicates the content of the toxic and hazardous substances in the component is below the limitation required in SV 1363 -2006 standard. × indicates the content of some toxic and hazardous substance in the component is above the limitation required in SJ n 1363-2006 standard.

1."Framework" of component the name, including the external framework and internal components.

(2) Electronic Information Product Pollution Control Identification

The national [Electronic Information Product Pollution Control Management Method] published on Feb 28th, 2006, identifies the environmental protection service life of this product. It will not have a profound impact on environment pollution, the human body, and property within the age limit from the production date as long as complying with the safety and use considerations. The electronic information products shall be recycled and reused as required in the laws and regulations of various regions when they complete normal use and are abandoned. (3) Package Recycling Marks (GB 18455-2001)

Various package materials are identified according to the package recycling marks (GB184552001).

Package materials shall be abandoned as required in the legal provisions in terms of package material recycling and reusing.

How to Connect and Watch Netflix

All projector with mirror display doesn't support playing protected video when you connect it to your smartphone directly. (Netflix, Prime Video, Hulu, etc)

Because these videos have an encryption protocol, the projector has no right to recognize when it is connected directly to the phone via the USB interface. Hope you understand.

(Projector without mirror display, need an HDMI adapter if you want to connect it to your smartphone)

Please follow the ways below to watch Netflix:

First Solution:

You can watch Netflix via chromecast /laptop/tv stick/Roku on our projector.

Second Solution:

You can connect the computer/ Smart TV to the projector through HDMI when playing movies from Netflix.

Third Solution:

You can buy a Wireless HDMI Dongle to mirror your phone.

The reason why the fire stick or other HDMI device can play Netflix is that the HDMI interface encryption protocol includes Netflix's.

It works with youtube, chrome, safari, and Facetime when you connect it to a smartphone directly.

Important Safety Considerations

The following safety instructions ensure a long service life of the projector and prevent fire or electric shock. Please make sure you carefully read the instructions and pay attention to all the following warnings.

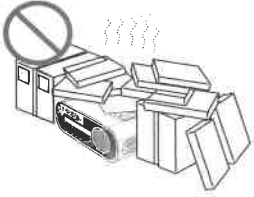

1. Do not install the projector in places without proper ventilation.

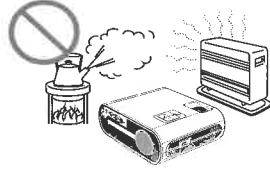

2. Do not install the projector in hot and humid places.

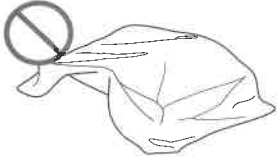

3. Do not install the projector in dusty or smokey places.

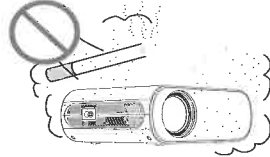

4. Do not block the ventilation holes (intake or exhaust).

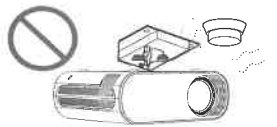

5. Do not install the projector near the temperature and smoke detectors. It may cause a sensor failure.

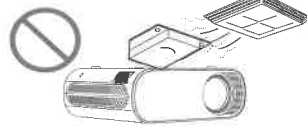

6. Do not install the projector in areas where warm and cool air will blow directly onto the projector. Otherwise it may cause projector failure due to moisture condensation or large temperature changes.

4

Important Safety Considerations

Installation

- Please use the projector in a dark room for best results.
- Please use the projector with caution to avoid dropping or shocking, which may damage the internal components.

Power Supply

- Use the power cord with caution to avoid unduly bending. A damaged power cord may cause electric shock or fire.
- Unplug the power cord from the outlet after using the projector.

Cleaning

- Unplug the power cord from the projector.
 - Use a wet cloth to clean the cabinet regularly. The neutral detergent may be used for serious smudges. Do not use strong detergents or solvents such as alcohol or diluent.
 - Use an airbrush or lens paper to clean the lens and be careful not to scratch or abrade them.
 - Please clean the ventilation opening and the loudspeaker regularly with a cleaner. The projector will be overheated with blocked dust, causing the failure.
- Please use the projector with a soft brush. Do not use rigid accessories such as a crevice cleaning tool, to avoid damage to the projector.

Notes on Fire and Electric Shock

- Make sure of adequate ventilation and unblocked outlet to avoid heat accumulation within the projector.
- Prevent foreign objects from falling into the projector, such as paper clips and paper scraps, do not attempt to retrieve any such object. Do not insert any metal object, such as an iron wire or a screwdriver, into the projector. Make sure to immediately turn off the power and ask qualified professional maintenance personnel to remove any object falling into the projector.
- Do not place any liquid on the projector.

Moving

- Please use soft package materials and attach the lens cover to protect the lens when moving the projector. Also, do not impose severe mechanical vibration on the projector.

High Temperature Warning

- During and after the projection, the temperature near the outlet will rise, therefore touching may cause burns. Do not peep at the lens, or it may cause severe eye injury.

Installed Away from Walls

- Please leave at least 30cm from the wall to maintain the projector's performance and reliability.

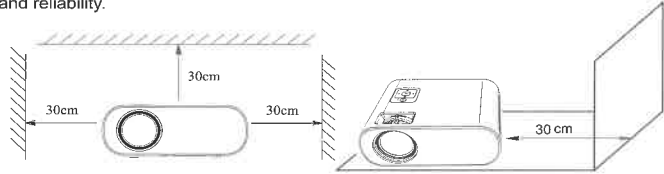

5

Check Before Use Names and Functions of Projector Components

► VISUAL INSTRUCTIONS

• Top View

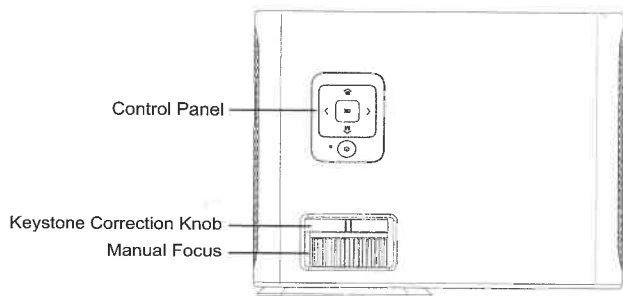

• Control Panel

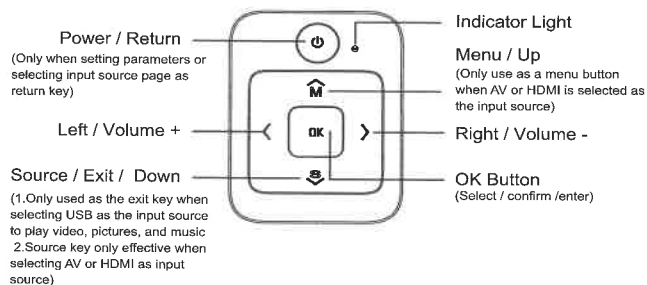

6

Check Before Use Names and Functions of Projector Components

• Bottom View

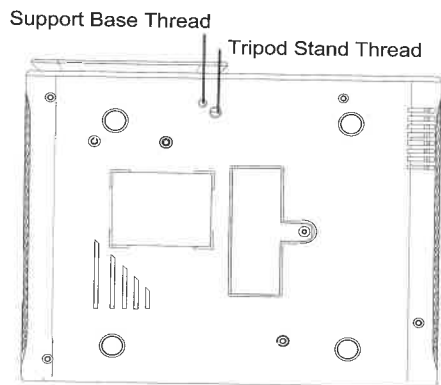

• Rear View

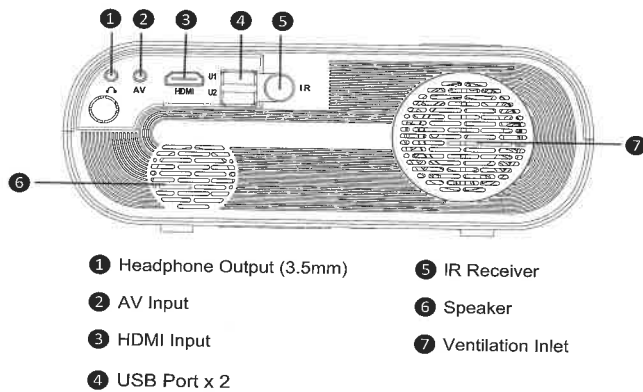

7

Check Before Use Get to Know the Remote Control

• Remove Control

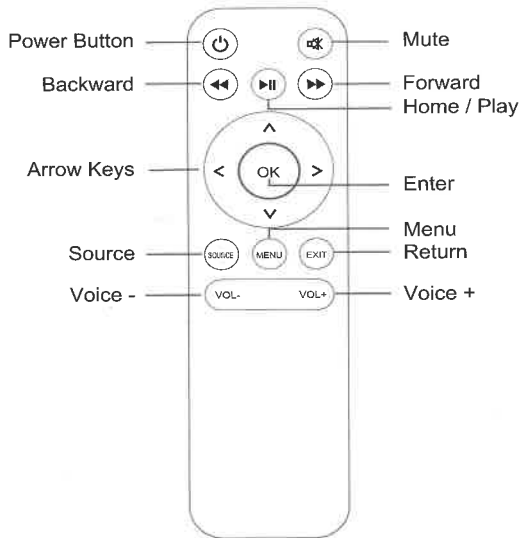

Attentions! :

Please be careful when operating the remote control. Do not drop or tread on the remote control, or splash any kind of liquid into the remote control.

Do not place the remote control near a heat source, in a place exposed to direct sunlight, or in a damp room.

8

Check Before Use Equipment Connection and Equipment

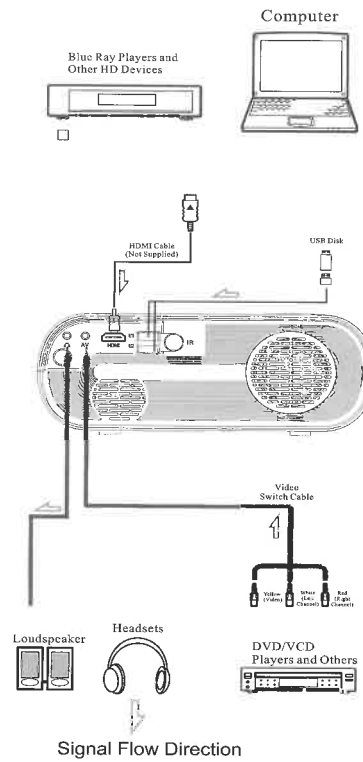

Connect the USB drive

- ① Different from other devices when you connect a USB drive, you don't need to click "source" to select the USB signal source, directly select the file you want to play on the main menu.
 - ② To play a video stored in a USB drive, select "Movie" on the main menu, and press the "OK".
 - ③ To play a picture, or music on a USB drive, select "Photo"/ "Music" on the main menu, and press the "OK".
- Note: The chip of this projector is not compatible with files stored in a USB stick in PPT format. (If you want to play PPT, please store the PPT document on your laptop or DVD player, then connect this projector to them).

Connect AV video devices

- ① Use the 3 in 1 video cable (Included in the package) to connect with AV.
- ② Choose the media signal channel: "AV".

Connect 3.5mm audio devices

Support 3.5mm earphones and other cable sound devices.

9

Connection Instructions

Note:

- ① HDMI interface can be connected to the computer or other devices with the HDMI output interface.
- ② Choose the media signal channel: "HDMI".

Add: Different brand laptop output keys are as follows:

Lenovo	Fn+F3	Fujitsu	Fn+F10
Dell	Fn+F8	Haier	Fn+F3
HP	Fn+F4	NEC	Fn+F3
ThinkPad	Fn+F7	Panasonic	Fn+F3
Asus	Fn+F8	Sharp	Fn+F5
Acer	Fn+F5	Hitachi	Fn+F7
Samsung	Fn+F4	TOSHIBA	Fn+F5
Sony	Fn+F7		

The user of windows 7 or over windows 7. Simply press the  +P, select "copy" to connect. If the operation above is invalid, Please update the computer graphics driver.

Connection Instructions

Smartphone connection

For IOS devices

By using the lightning to HDMI/USB adapter(lightning to HDMI cable adapter), you can connect your iOS device to this projector easily(NOT INCLUDE ADAPTER)

For Android devices

This projector allows you to connect to your Android mobile phone with Micro USB / type to HDMI/USB(NOT INCLUDE ADAPTER)

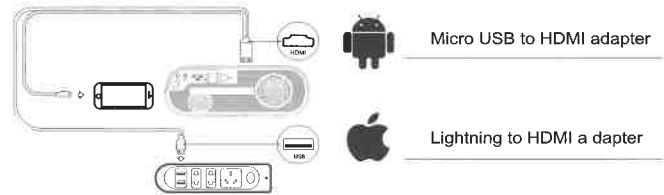

NOTE:

1. Please kindly note that the adapter was not included in the package.
2. Please also make sure to choose HDMI as the input source after the connection.
3. Because there are different versions of Micro USB/Type C / Lighting to HDMI adapter cable and different models of smartphones, the Micro USB/Type C / Lighting to HDMI adapter cable may not be compatible with your smartphone, and there is a problem that it cannot be connected. Has nothing to do with the projector, you can try another adapter cable
4. All Micro USB / Type C / Lighting to HDMI cable in the market cannot support mobile phones to play NETFLIX, Hulu, amazon prime video projection, which has nothing to do with the projector.

Connection Instructions

Bluetooth Connection

Warm Tips:

Bluetooth projector can only be used to connect sound devices such as speakers, headphones, sound bar, etc, not to computers or smartphone.



How to Connect the Bluetooth Device:

Auto & Static Connection Method:

When you are trying to connect to a Bluetooth device, please make sure the Bluetooth device is on and in Bluetooth pair mode before connect.

1.Start the Projector and click on "Setting" - "SOUND" - "Bluetooth Settings"(as shown above), turn on the Bluetooth- then press "arrow key" select "Auto", the Bluetooth device name will be shown on the screen and will connect it automatically.

2.Start the Projector and click on "Setting" - "SOUND" - "Bluetooth Settings"(as shown above), turn on the Bluetooth- then press "arrow key" select "Static", Bluetooth devices name will be shown below, select the right device and press the "OK key" to connect it.

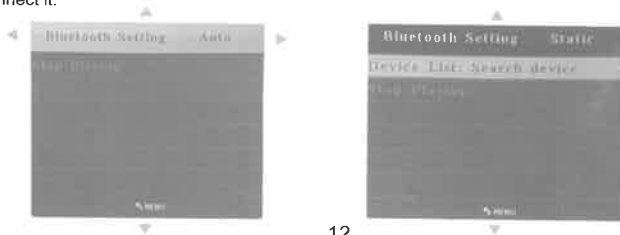

12

How to Install and Debug a Projector Quickly Installation and Debugging

1 Install the Projector

You can choose to place the projector on the horizontal place or attach it to a hanging bracket.

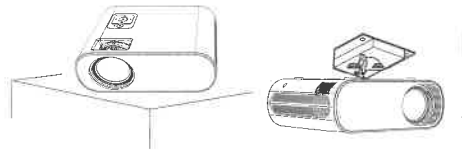

Horizontal Placement

Hanging Bracket Installation

Attentions! :

The hanging bracket is an accessory that is not supplied.

2 Adjust the Focal Length

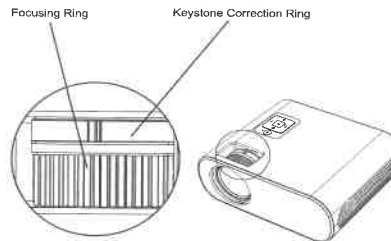

Distortion Image Diagram



Keystone Distortion



Blurred Image

Adjust the projector's keystone correction ring and the focusing ring to obtain a satisfactory image.

It is recommended to adjust the keystone correction ring in case of keystone distortion in the image (Figure 1 on the right).

When the screen image is blurred (Figure 2 on the right) it is recommended to adjust the focus ring to improve the picture definition.

Please move forward or backward proportionally in case the adjustment is unable to obtain the satisfactory definition.

13

How to Install and Debug a Projector Quickly Keystone Correction

1 Vertical keystone correction

1) The vertical keystone correction is required when ① and ③ below appear during the first installation and use.



2) Dial the keystone button left and right to adjust the picture to the quadrangle as shown in ② to finish the vertical keystone correction.

2 Horizontal keystone correction

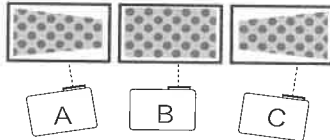

A: If the picture is big on the left and small on the right, slightly swing the projector to the right to correct the picture.

B: Please refer to the picture. It is normal if the project is slightly oblique.

C: If the picture is big on the right and small on the left, slightly swing the projector to the left to correct the picture.

Adjust the Image Projector on the Screen

Check the horizontal and vertical screen settings.

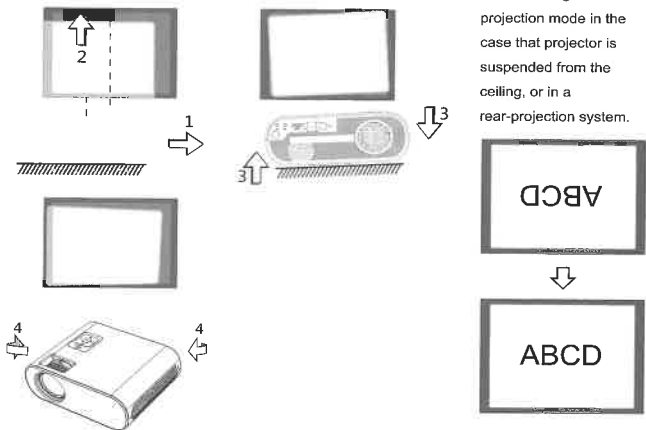

! Attention:

Please change the projection mode in the case that projector is suspended from the ceiling, or in a rear-projection system.

- (1) Please move the projector to one side in case of left or right screen offsets. (Align the screen center to the projector lens center)
- (2) Please adjust with the front adjuster for vertical offsets.
- (3) Please place the projector on a horizontal plane for angle offsets.
- (4) The projection screen as shown in the figure indicates the projector has not aligned with the screen. Please adjust the projector's location with align to the screen.

Start Using Projection Settings

1. Options related to "Image" are set in this screen.

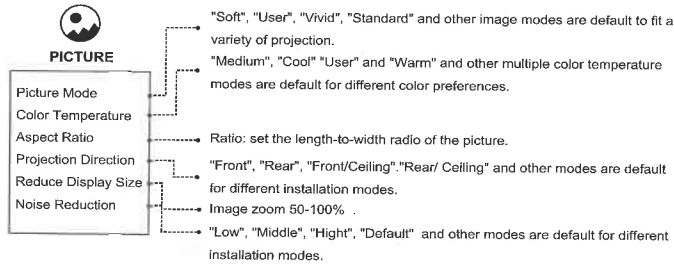

Attentions! :

Different installation modes of the projector are as follows:

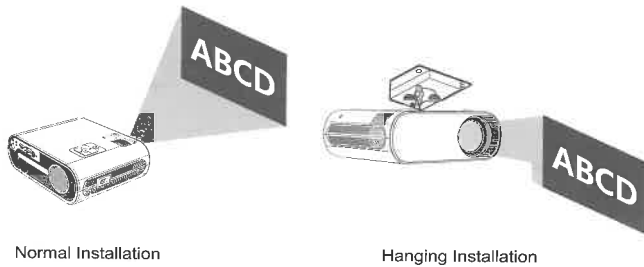

Start Using Projection Settings

2. Options related to "Audio" are set in this screen.

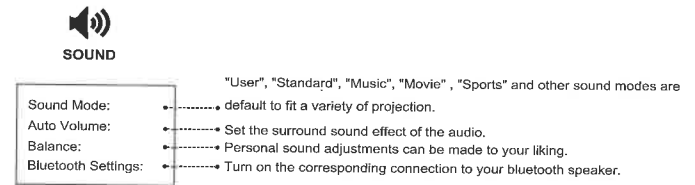

3. Options related to "Sleep Timer" are set in this screen.

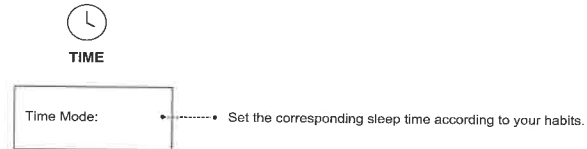

4. Options related to "OPTION" are set in this screen.

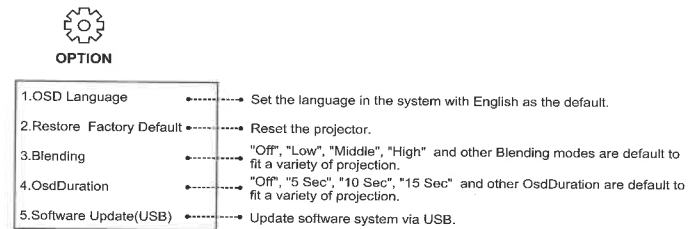

Safe Shutdown Correct Shutdown and Storage

The projector can be shutdown and be stored safely in the following steps.

1. Press the key  on the operation panel or the remote control of the projector and shut down the projector according to system prompts.
2. Screw in the focusing ring to ensure the lens is fully stored inside the projector.

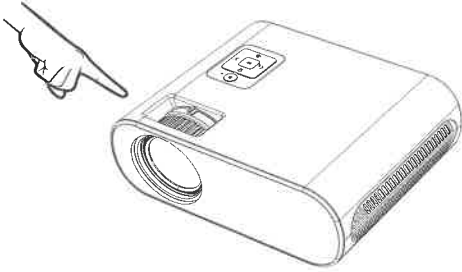

3. Cover the dustproof lens to the lens, and store the device in a dry and cool place.

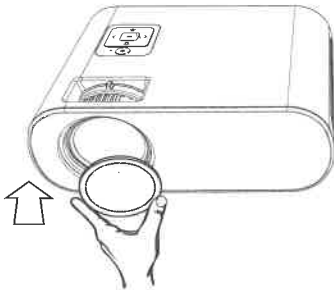

Attentions! :

Do not place the projector
indirect sunlight

18

Maintenance Cleaning Method

Make sure to unplug the power plug from the power outlet before cleaning. Do not use insecticides or other volatile chemicals on the projector or lens.

Also do not allow the projector in long contact with the rubber or vinyl products. It will result in a damaged or peeling coating.

Clean the Projector

Wipe the projector with a soft and dry cotton cloth. Wipe using a soft cloth with diluted neutral detergent and wipe up with a dry cloth for very serious smudges. Please comply with the attention for wiping with a chemical fiber cloth.

Do not use thinner, benzene, or other solvents to avoid lower quality or spraying coating peeling off.

A brush can be inserted in the front of the cleaner for cleaning the air vent. Avoid direct use of the cleaner without any joints or nozzles.

Do not scrap the projector's main part with nails or other rigid objects to avoid scratching.

Lens Smudges

Clean with the same method as the camera lens: use the cleaning web roller for professional air blowers or glasses lenses. Be careful not to scrap the lens.

Cleaning the inlet and outlet

Dust at the inlet and outlet prevents air ventilation, resulting in temperature rise and causing failure. Cleaning guideline: clean once at least every 10,000 hours of use. Turn off the power and disconnect the power cord.

Clean the external with an electric dust collector. Install a brush head converter on the cleaner. Please note that do not use the cleaner without a converter or an adapter without a brush head.

19